



Mobile jaw crusher

MOBICAT MC 110(i) EVO2



A LONG HERITAGE OF EXPERTISE

Efficient crushing and screening plants.

For the past 100 years, KLEEMANN GmbH has been developing and manufacturing machines and plants for the natural stone and recycling industries.

High levels of performance and innovative details, simple handling and maximum safety for the operator - this is what KLEEMANN crushing and screening plants stand for.



THE KLEEMANN PRODUCT RANGE

- MOBICAT**
Mobile jaw crushers
- MOBIREX**
Mobile impact crushers
- MOBICONE**
Mobile cone crushers
- MOBISCREEN**
Mobile screening plants
- MOBIBELT**
Mobile stackers

Over 100 years of
tradition

A WIRTGEN GROUP Company
An internationally active group of companies



With more than 200
subsidiaries and dealers in Germany and abroad



MOBICAT MC 110(i) EVO2

The efficient key player.

The MOBICAT MC 110(i) EVO2 jaw crusher has very wide range of applications as a compact primary crusher and is extremely flexible in transport and use. The plant can be operated easily and intuitively, stands out with a variety of control and overload systems, and is extremely powerful and efficient in operation.

The MOBICAT MC 110(i) EVO2 is designed for a very wide variety of application conditions and feed materials. Thanks to its compact design and transport height of 3.40 m, the machine is easy to move. Its fast set-up, which can also be carried out remotely, even enables short-term applications.

The powerful drive concept easily masters changing application conditions. Today in natural stone, tomorrow in recycling – the MOBICAT MC 110(i) EVO2 is compact, efficient and intelligent.



Cost-effectiveness
at its best



Operability at its
most intuitive



And always with an
eye on sustainability



MOBICAT
EVO²

THE HIGHLIGHTS

Perfectly equipped.



- > Excellent accessibility and high level of safety
- > Easy transport thanks to hydraulic functions

01 Feeding unit

- > Feeding unit with foldable hopper walls for fast and safe set-up

02 Prescreening

- > Effective primary screening through independent double-deck prescreen

03 CFS (Continuous Feed System)

- > Innovative feed control with CFS (Continuous Feed System) guarantees optimum material flow

04 Crusher unit

- > Crusher unit with extra-long articulated crusher jaw for barrier-free material intake

05 Control and overload systems

- > Effective control and overload systems guarantee maximum machine availability

06 Drive

- > Efficient and powerful diesel-direct drive

07 Operating concept

- > Easiest possible operation with the SPECTIVE operating concept
- > With SPECTIVE CONNECT, important information is available directly on your smartphone



A WELL CONCEIVED FEEDING UNIT

For short set-up times.

up to 400 t/h
Feed capacity

approx. 4.4 m³
Hopper volume

approx. 7.5 m³
Hopper volume with hopper extension



The MOBICAT MC 110(i) EVO2's feeding unit is generously dimensioned and the design of the chute ensures an optimum material flow.

The feeding unit can be folded hydraulically, conveniently and safely via the radio remote control. Locking also takes place by radio control without requiring additional work from the ground.

As an option, an additional hopper extension or a filling aid are available to enable a rear-side loading width of 3.6 m.

The design of the vibrating feeder has been revised in comparison to the predecessor model (based on the chute of the MOBIREX MR 110/130 EVO2) and ensures an even better material flow and increased feed capacity.

Optimised output capacity - thanks to ideally prepared feed material

The composition of the feed material and the feed size have a significant influence on output capacity. To guarantee trouble-free and low-wear operation, the feed material should be prepared as well as possible.

- > Take note of the size and edge length of the material
- > Select the feed size to match the final grain size and max. permissible reduction ratio
- > Sort out any uncrushable material, e.g. steel beams, cables, wood, films/foils
- > Ensure uniform loading of the plant - an overfilled feed hopper and a continuously empty feed hopper can lead to increased wear

KLEEMANN > PROCESS KNOWLEDGE

In many cases, feed capacity, crushing capacity and plant performance are treated synonymously or mixed up. What's what?

Crushing capacity
= quantity produced by the crusher ■

Feed capacity
= crushing capacity ■ + primary screening capacity ■
+ bypass capacity ■

Plant performance
= crushing capacity ■ + bypass capacity ■

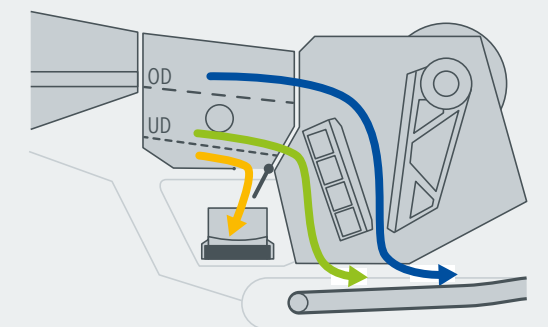

EFFECTIVE PRESCREENING

For better results and less wear.

The less fine material is introduced to the crushing process, the better the productivity, final product quality and wear behaviour.

The MOBICAT MC 110(i) EVO2 has an independently vibrating double-deck prescreen: The feed material is screened out effectively so that the fines content and the material that already corresponds to the desired final grain size is directed past the

crushing chamber. A higher throughput is achieved and, at the same time, plant wear is reduced. The prescreen works independently of the vibrating feeder and is therefore particularly productive.



High product quality
through prescreening

Fines discharge
via side discharge conveyor

Large selection
of prescreen coverings



The bypass flap can be used to guide the material flow of the primary screening. It is installed directly onto the prescreen. The screen vibrations can therefore achieve a self-cleaning effect.

- > Higher quality of the final product through discharge of fine particles via the side discharge conveyor
- > Bypass flap for simple redirecting of the material stream (sub-floor no longer required!)
- > Reduction in wear and increase in output by redirecting medium grain through the large crusher bypass device

Side discharge conveyor is extremely flexible in use

The side discharge conveyor is available in two versions, can be installed on both sides and can remain on the machine for transport. This makes discharge heights of up to 2,940 mm possible (optional long belt; short belt: 2,050 mm). The belts are provided with a spray system to reduce the dust load.

KLEEMANN > PROCESS KNOWLEDGE

Optimum prescreening set-up

In order to tune the prescreening ideally to the material or application, the frequency of the prescreen can be adjusted steplessly. The correct selection of the screen surface is also important. Slotted grates or hexagonal screen surfaces are therefore available for the upper deck. The hexagonal design creates a significantly raised open screening surface and, thanks to a conical hole progression, reduces clogged material. The lower deck can be operated with wire cloth of different mesh sizes.

The result: high product quality, maximum plant performance and less wear.

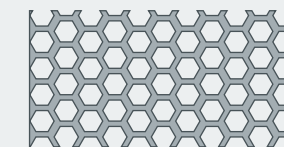

> Hexagonal screen surfaces

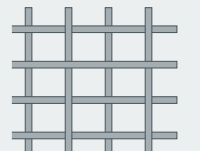

> Wire cloth



> Slotted grate

The screen surfaces are compatible with the MC 110 EVO1.

CONTINUOUS FEED SYSTEM (CFS)

Higher efficiency thanks to uniform loading.

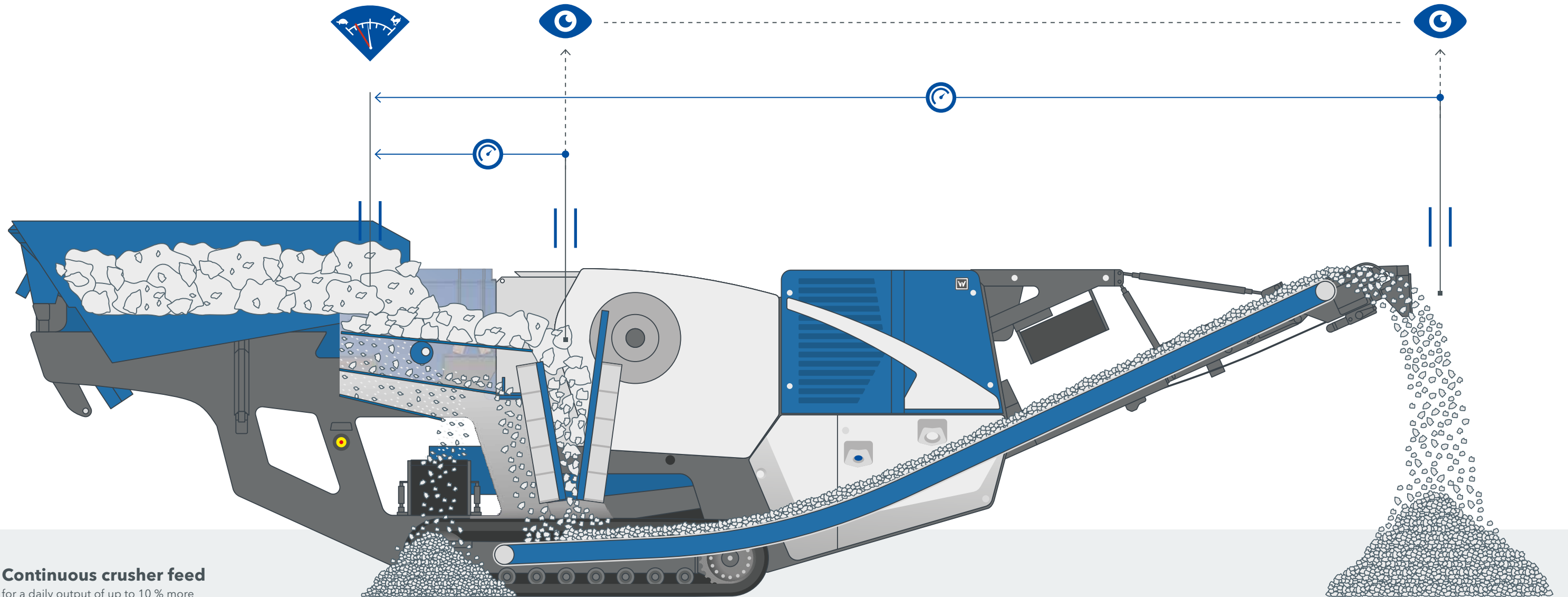

Continuous crusher feed

for a daily output of up to 10 % more

Uniform loading is indispensable for a good end-product, optimum throughput and low wear.

To ensure that the crushing chamber is always uniformly filled, the Continuous Feed System (CFS) monitors the crusher level and, with the line coupling option, the height of the stockpile with an ultrasonic probe.

Independently of this, the CFS regulates the frequency of the vibrating feeder and prescreen. A backlog is therefore avoided and crusher utilisation is optimised. The MC 110(i) EVO2 is

equipped as standard with a CFS as control system. The CFS facilitates the operator's work because the machine automatically regulates a homogeneous material flow, therefore ensuring optimum crusher loading.

KLEEMANN > PROCESS KNOWLEDGE

The CFS controls the vibrating chute speed so that the material on the chute does not pile up too high. Fine content can therefore be screened out before it runs through the crusher.

Result: The crusher only has to deal with the material that really needs to be crushed!

POWERFUL CRUSHER UNIT

The heart of the machine.

Powerful crusher unit for high crushing capacity and throughput.

The MC 110(i) EVO2's crusher unit is the centrepiece of the machine. Its extra-long articulated crusher jaw guarantees optimal material intake. Innovative functions such as the simple

gap setting or the crusher unblocking system deliver genuine added value.



1,100 x 700 mm
Crusher inlet

Fully hydraulic
Gap setting

160 kW
Crusher direct drive

- 01** Optimised crusher geometry with long crusher jaw
- 02** Extensive selection of crusher jaws: Regular Teeth, Sharp Teeth, Wavy Teeth
- 03** Gentle material transfer thanks to an adjustable deflector plate
- 04** Mechanical overload protection thanks to the pressure plate
- 05** Crusher unblocking system (optional)
- 06** Convenient gap setting via push-button

Crusher geometry

The crusher geometry features an optimum design. Flattened transfer from the prescreen or vibrating feeder to the crushing chamber means the material can tilt into the crushing chamber without any restrictions. When the articulated crusher jaw is pulled up, the material cannot pile up and fewer blockages are created.

The crusher outlet's deflector plate guarantees gentle material transfer onto the crusher discharge conveyor. The large material tunnel prevents blockages and is easily accessible

from the side. The deflector plate can be moved into two positions to protect the crusher discharge conveyor against damage - replaceable wear plates are available as options.

Result: high throughput combined with high reliability.

Crusher gap setting

The gap setting can be performed conveniently and safely via radio remote control. Adjustment throughout the entire gap-setting range of 30-180 mm is made fully hydraulically by means of a wedge system. This means higher application flexibility and stable process reliability in the event of overload.

Rule of thumb: The closed side setting is calculated from final grain size = 1.6 x CSS. With a desired final grain size of 0-120, the optimum CSS would therefore be 75 mm.

Crusher unblocking system

If material bridging or a standstill with full crusher should occur, the optional crusher unblocking system is ready to provide assistance. Start-up in standard and opposite directions is also possible with a full crushing chamber. Blockages can therefore be quickly broken up and do not have to be cleared manually.

Result: Short downtimes in the event of obstructions in the crushing chamber, without having to clear stones from the crushing chamber.



01

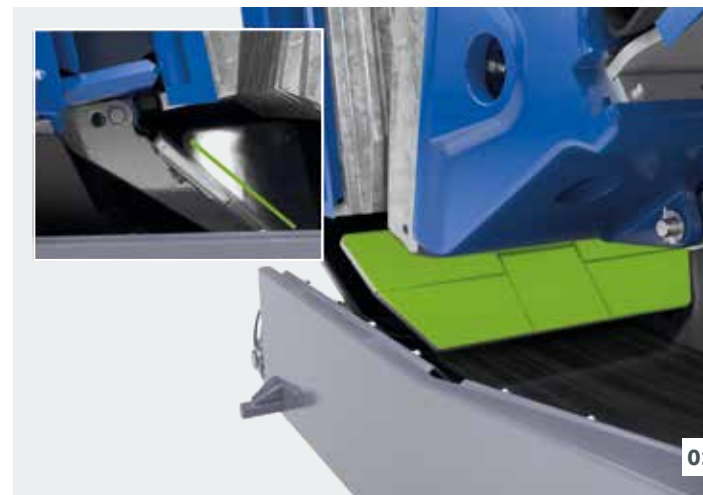

02



03

01 Crusher geometry 02 Deflector plate 03 Crusher unblocking system

KLEEMANN > GOOD TO KNOW

Thanks to optimised access to the side wedges, the crusher jaw can be replaced quickly and easily. Advantage: short machine downtimes when changing the fixed crusher jaw.

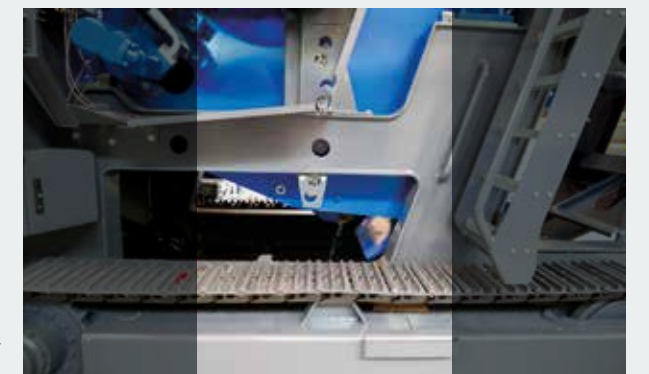

EFFECTIVE CONTROL AND OVERLOAD SYSTEMS

To protect the plant.

During the crushing process, various short-term or prolonged overload situations can arise. With the MOBICAT MC 110(i) EVO2 jaw crusher, intelligent automation systems protect against damage and failures.

A distinction is made in this regard between control and overload systems:

- > Control systems are used for intelligent process optimisation for a continuous and efficient crushing process.
- > Overload systems are integrated for self-protection of the plant to detect and counteract short-term overloads at selected points (e.g. metal in the feed material).

the software detects the overload and intervenes to control it: the loaded volume is reduced, the filling level of the crushing chamber is adjusted and the forces acting on the housing and rocker are therefore reduced. If, on the other hand, an underload is detected, the crusher filling level is increased step by step to guarantee an optimum plant performance. **Result:** the plant can be operated safely

CFS and LRS control systems

The CFS control system described serves to optimise the crushing process and guarantees the best possible crusher loading (see page 14). Crushers being operated beyond their permissible load range can result in serious damage. The LRS Load Reduction System, which works closely together with the CFS, has the task of preventing this. The "load monitor" in

CONTROL SYSTEMS



CFS

Optimisation of crushing process



LRS

Long-term crusher protection

OVERLOAD SYSTEMS



Overload stage 1



Overload stage 2



Overload stage 3

Fast response to overloads



Overload systems - fast response to overloads

Overload situations at selected points arise due to hard material or uncrushable foreign materials in the feed material – frequently in recycling applications. To avoid expensive crusher damage, a pressure plate is installed as predetermined breaking point as a last mechanical safety element.

Breaking of the pressure plate leads to machine standstill. With different designs of overload systems, this can be avoided with the MC 110(i) EVO2:



Stage 1 - Gap opening over adjusting range:

- > Open the cylinders over the entire crushing gap
- > Automatic repositioning of the crushing gap to the previously set value

STAGE 1

complete gap area opens in **40** seconds

Recommended use

- > With feed material where hardly any foreign material is expected
- > In natural stone and recycling (small amount of foreign material)



Stage 3 - Active overload system with pump (option):

- > With activated overload system, very fast opening of the cylinders via crusher gap adjustment
- > Automatic repositioning of the crushing gap to the previously set value

STAGE 3

complete gap area opens in **2** seconds

Recommended use

- > For applications where a lot of foreign material is expected, high quality requirements of the final product
- > In recycling



Stage 2 - Preparation of overload system (option):

- > Faster opening of the cylinders over the entire crushing gap
- > Automatic repositioning of the crushing gap to the previously set value

STAGE 2

complete gap area opens in **20** seconds

Recommended use

- > For applications where a high volume of foreign material is expected, oversize grain in the final product is not problematic
- > In recycling

KLEEMANN > GOOD TO KNOW

In difficult applications with a high share of foreign material such as metal (e.g. in recycling), frequent overloading of the crusher is possible. If the machine is not equipped with a capable overload system, the mechanical pressure plate is the last resort to prevent serious damage to the crusher. Pressure plates are expensive and complex to install.

Cost savings through prevention of crushing through the pressure plate:



> Machine produces 200 t material an hour



> Production stop due to broken pressure plate: approx. 4 hours

4 €/ton

> Final product is sold for 4 €

3,200 €

>> pure downtime costs + costs for pressure plate + personnel costs for fitter

= the use of an overload system is worth it!

INNOVATIVE DRIVE CONCEPT

Impressive performance - with the best possible consumption values.

The MOBICAT MC 110 (i) EVO2 features an innovative "diesel-direct-electric" drive concept - it is both powerful and economical.

The MC 110(i) EVO2 stands out with its holistic drive concept with an efficient diesel-direct drive where the crusher is driven via a fluid coupling from the diesel engine. The power- and load-dependent fan ensures a low-noise and even more economical operation. Via a power splitter gearbox, the generator is driven by a generously dimensioned cardan shaft, which

means that the more maintenance-intensive timing belts of the predecessor model are not required. The drive system pumps are activated via a clutch coupling and can therefore draw on the full power of the diesel engine. All other hydraulic pumps for auxiliary and set-up functions and for the cooler drive are also driven via the gearbox.



The plant can be optionally equipped with a heat package (-15 to +50 °C) or cold package (-25 to +40 °C).

The "Quick Track" option can be used to move the plant with the crusher running and the conveyor unit switched off.



KLEEMANN > PROCESS KNOWLEDGE

Thanks to the output- and load-dependent fan, the basic configuration of the plant is already very low-noise. **If the machine is additionally equipped with the noise protection package, the plant can be operated without noise-absorbing headphones - depending on the environmental conditions and local regulations.**

The noise-protection package includes power pack sealing and a power pack housing made of noise-insulating material with a sound conduction system upwards.

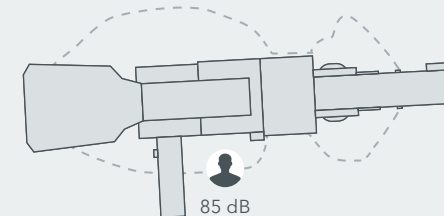

MC 110(i) EVO2 with noise-protection package

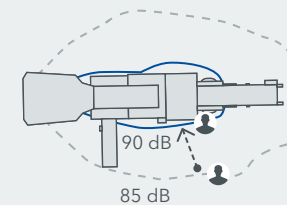

MC 110(i) EVO2 without noise-protection package

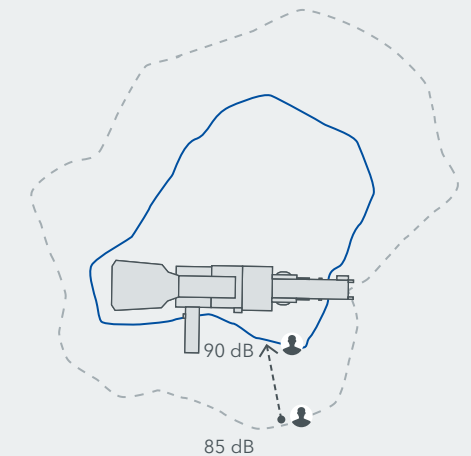

MC 110 EVO

Diesel-direct-electric
Drive

240 - 248 kW
Drive output



up to 30% less consumption
compared to hydraulic drives

ECO mode

for reduced fuel consumption and wear in idle phases

INTUITIVE OPERATING CONCEPT SPECTIVE

For a better result.

With the increasing demands being placed on modern crushing plants, their complexity also increases. At the same time, the technology must be safe and as easy as possible to master - without requiring long training sessions. This is precisely where the strength of the SPECTIVE operating concept lies.

The MOBICAT MC 110(i) EVO2 can be operated simply and intuitively with the different SPECTIVE components. Apart from the touch panel, the holistic operating concept includes a

large and small radio remote control and the SPECTIVE CONNECT digital solution.



01 Touch panel and operating buttons

From the starting procedure to making the initial settings, from the elimination of malfunctions all the way through to maintenance - on its 12" touch panel, SPECTIVE provides users with all important plant information in a clearly arranged manner and enables all plant settings from a single location. The optimised arrangement of the button below the display and guarantees high operating comfort. The lockable operating mode selector switch also protects against misoperation. The user guidance and visualisation of the operating process are even more clearly presented. The aids for troubleshooting contribute to minimising of downtimes.

02 Radio remote control

The new radio remote control permits operation of all plant functions, including the complete set-up and driving operation, from a safe distance. When it has been set once and put into operation in automatic mode, for most procedures the operator no longer has to go to the plant. Furthermore, advantages in the field include the high battery runtime (> 10h) with LED for battery charge indication, fill level indicator and charge status display, and a battery change without an emergency stop.

03 Small radio remote control

The small radio remote control is suitable to carry in the loading device thanks to its compact size. All relevant functions can therefore be operated in automatic mode conveniently in the excavator or wheel loader. The small radio remote control is the ideal complement to SPECTIVE CONNECT.

04 SPECTIVE CONNECT

With SPECTIVE CONNECT, users receive a display of the user interface via smartphone wherever they are working - for example, in the excavator or wheel loader. Apart from relevant data such as speed, consumption values and fill levels, fault messages or warnings are also displayed. In addition, important process and machine data can be summarised in a report and conveniently transmitted.



KLEEMANN > GOOD TO KNOW

Everything at a glance with WITOS®

The WITOS FleetView telematics system supports operators with efficient **fleet and service management**. Information on the operating status of the machines is available independently of location and time. Even users with only one machine benefit from WITOS.

From support for maintenance and diagnostic processes to the targeted monitoring of the machines: the range of services is diversified and it is an ideal complement to the WIRTGEN GROUP Smart Service agreements.

SPECTIVE CONNECT

Plant data on the smartphone.

SPECTIVE CONNECT is the logical extension of the original SPECTIVE because here the human interface of the crusher is brought directly to the operator in the excavator or the wheel loader.

SPECTIVE CONNECT can be used to display all relevant operating data such as engine speed, consumption, throughput (in conjunction with belt scale) and fill levels of the MC 110(i) EVO2, fault messages, warnings and other messages.

This way, work does not have to be interrupted for the operator to view the status. The option for preparing and sending a clearly arranged report creates additional transparency for the operator.

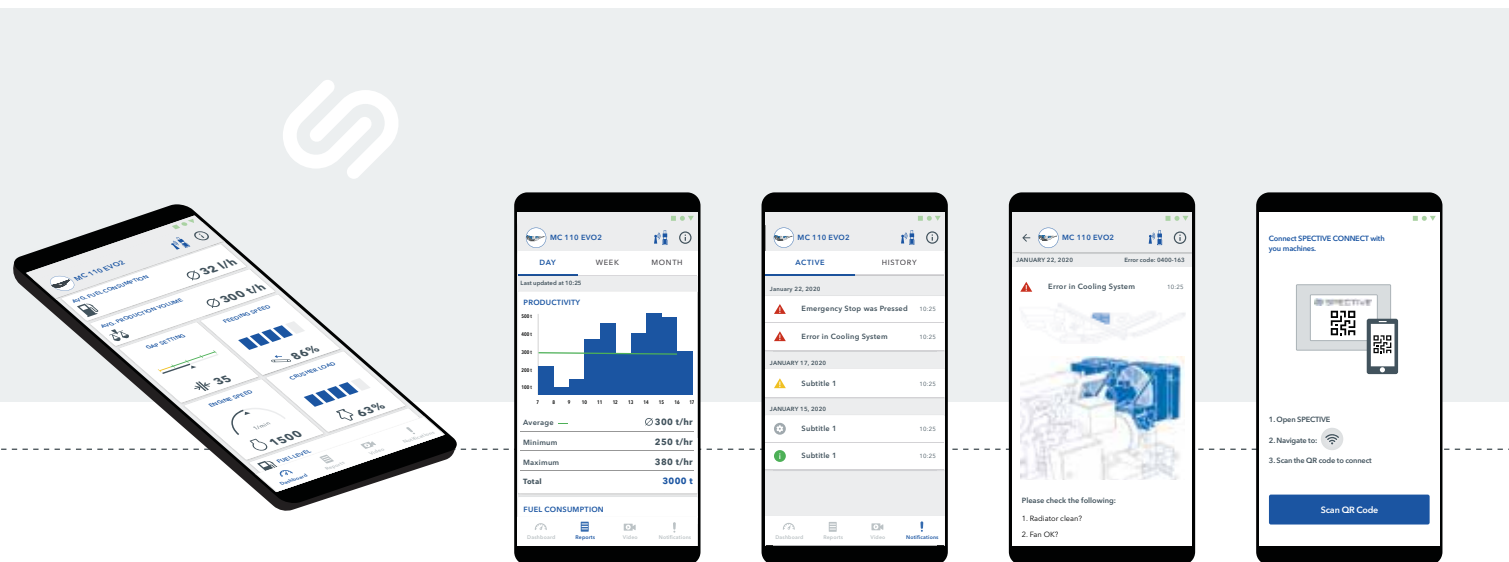

02 Fault elimination aids

All active faults incl. fault history, warnings and messages can be displayed in the same manner as the SPECTIVE touch panel. The operator knows what has to be done and is also supported in a targeted manner with fault elimination by means of remedies.



02



01

01 Dashboard

A non-verbal display provides a clearly arranged presentation of all information on the crushing plant relevant to the operator:

- > Average fuel consumption
- > Average production output
- > The current gap-setting



03

03 Reporting

A clearly arranged report on the crushing plant's operation and output allows the operator and operating company to draw conclusions regarding current plant utilisation.

The following can be displayed:

- > Average fuel consumption
- > Average production output (belt scale for crusher discharge conveyor)
- > Plant utilisation (when is the plant stationary, when is it fully utilised, ...)

The reports can be sent conveniently as a PDF.

KLEEMANN > GOOD TO KNOW

Is your plant ready for SPECTIVE CONNECT?

If your plant is equipped with the SPECTIVE CONNECT option, then simply download the app for your smartphone and get started!

1. Select the WiFi symbol on the SPECTIVE start screen.
2. Scan the QR code and you will be connected with the plant immediately.

Following this, the connection is always established when you are in the vicinity of the machine.



Scan the code for further information on SPECTIVE CONNECT



The availability of SPECTIVE CONNECT depends on the country-specific situation. Further information can be obtained from your local contact person or under www.wirtgen-group.com/spective-connect-kleemann

ACCESSIBILITY AND SAFETY

For high operating comfort.

A machine can be easy to operate and safe, but convenient maintenance is also very important to the operator.

All machine components are especially easy to access to guarantee trouble-free production, simple operation and fast service. A central drain point for fluids, for example, enables

ergonomic maintenance. Spray systems at different transfer points, as well as LED lighting for illuminating the work area, are included as standard in the basic configuration of the plant.

Central drain point



Additional options increase operating comfort

Optionally available Premium lighting provides even better illumination of the machine environment. Simple refuelling of the machine is possible from the ground or with the help of a refuelling pump for filling from tanks.

Focus is on safety

The MOBICAT MC 110(i) EVO2 is also ideally equipped in terms of safety features. All function- and safety-related cylinders are equipped with safety valves (lowering/brake holding valves). Each cylinder stays in its current position - to protect the machine operator and machine in the event of deactivation or failure. Thanks to plant operation via the radio remote control and therefore from a safe distance, safety on the construction site is also increased.

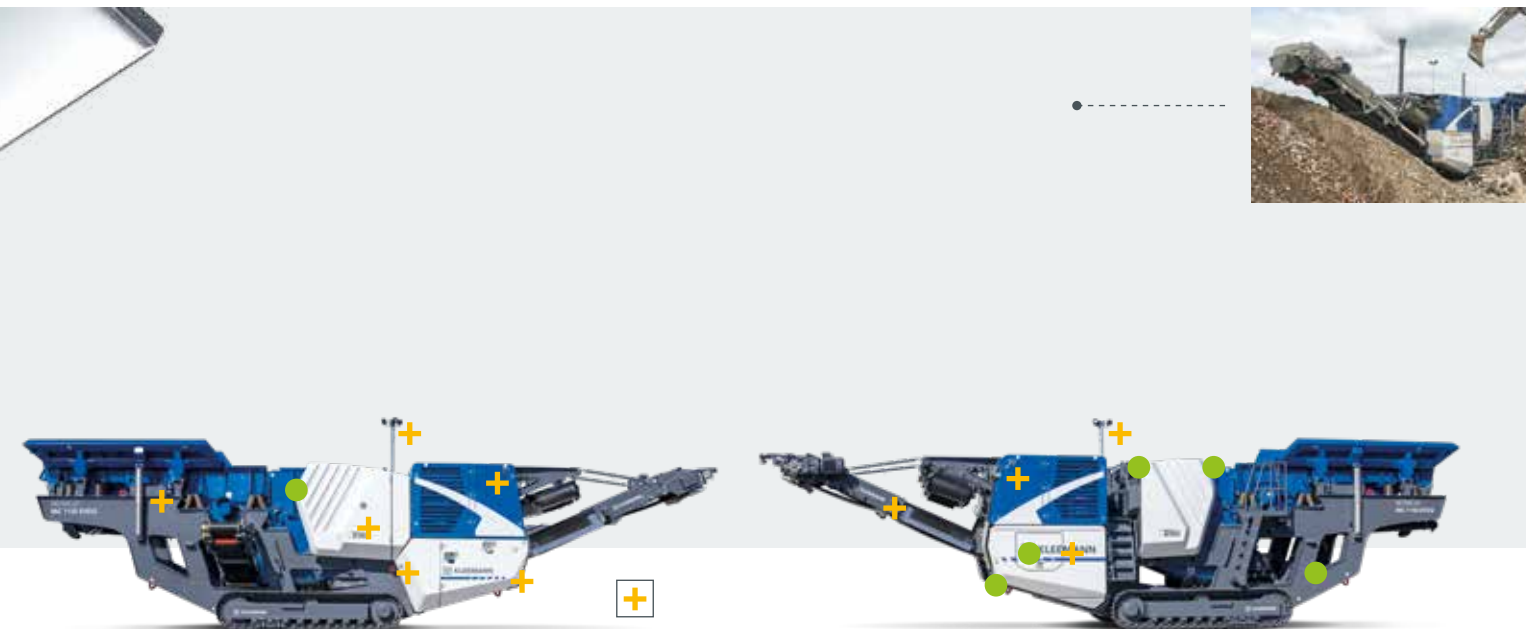

● Standard lighting + Premium lighting □ Mobile work lamp

Standard lighting

The standard lighting includes the illumination of the travel path, the steps and the area of the touch panel. A USB charging port for a mobile maintenance lamp is also available.

Premium lighting

The Premium lighting includes the lighting pole and other lamps for extended illumination of the machine environment as well as a mobile maintenance lamp.



SIMPLE TRANSPORT

Quickly on site. Immediately ready for work.

In spite of their impressive output values, jaw crushers from the MOBICAT EVO line belong to the compact class of primary crushers: low weight and compact dimensions enable frequently changing work locations.

The MC 110(i) EVO2 is extremely versatile and, thanks to its compact dimensions, can be deployed almost everywhere directly on site. Even narrow or difficult-to-access building sites in town centres are usually not a problem. And even if the work location changes frequently, the machine is quickly transportable and also quickly loaded thanks to its relatively light weight.

The transport height of 3.40 m allows the use of semi low loaders, which, in many cases, has a positive impact on transport costs.

The side discharge conveyor remains on the machine during transport and is moved into position in next to no time - just as the extended crusher discharge conveyor that is simply folded in for transport. The machine is ready to go after just a few steps.



High flexibility
for changing work locations



Short make-ready times
thanks to uncomplicated set-up

3,400 mm
Transport height

15,010 mm
Transport length

3,000 mm
Transport width

BROUGHT INTO LINE

For perfect combination versatility.

Process-related knowledge

The line coupling option allows KLEEMANN machines to be coupled with each other. The crushing process between the crushing plants is then optimised automatically so that material is always conveyed through the machines with maximum efficiency. A probe is installed at the crusher discharge conveyor and/or fine grain conveyor of the upstream machine, which monitors the fill level of the feeding unit of the respective downstream machine. When the fill level reaches a defined height, the output of the upstream plant is temporarily reduced.

For safety reasons, the crushing and screening plants are connected to each other by a cable. If an emergency stop button is pressed on the plant train in the event of an emergency, all machines are safely stopped.

MC EVO2 + MCO EVO2 + MS EVO

TARGETED TO SUCCESS

For perfect crushing results.

An ideal crushing result is always achieved when components of the complete plant are perfectly tuned to each other, combined with the settings made by the operator.

With these tips, it is possible to define the ideal settings for any task.

Feed material

- > Feed size: where possible, the maximum feed size should not exceed 90% of the specified crusher opening
- > Compressive strength: mineral materials can be used with a maximum compressive strength of 300 MPa *
- > Mineral type: all soft to hard natural stones, e.g. dolomite, granite, basalt, diabase, quartzite or gneiss as well as residual construction materials such as rubble, bricks and reinforced concrete

* Depending on the material and machine type, higher values are also possible

Crushing ratio

The maximum crushing ratio (ratio of feed grain size / grain output) largely depends on the physical properties of the feed material. The following standard values result:

- > 7:1 at < 100 MPa (recycling)
- > 5:1 at < 150 MPa (limestone)
- > 3-4:1 at < 300 MPa (hard stone)

Exceeding the crushing ratio leads to an undesirable decrease of the crushing capacity and to an increase in wear.



Areas of application of jaw crushing plants

NATURAL STONE

Limestone / sandstone, gritstone / greywacke / gravel / granite	Gneiss / marble / quartzite / diabase / gabbro / basalt	Iron ore	Coal	Clay
Demolished concrete / reinforced concrete / rubble	Asphalt	Blast furnace slag		Steal slag

RECYCLING

KLEEMANN > PROCESS KNOWLEDGE

MOBICAT MC 110(i) EVO2 crushing curve

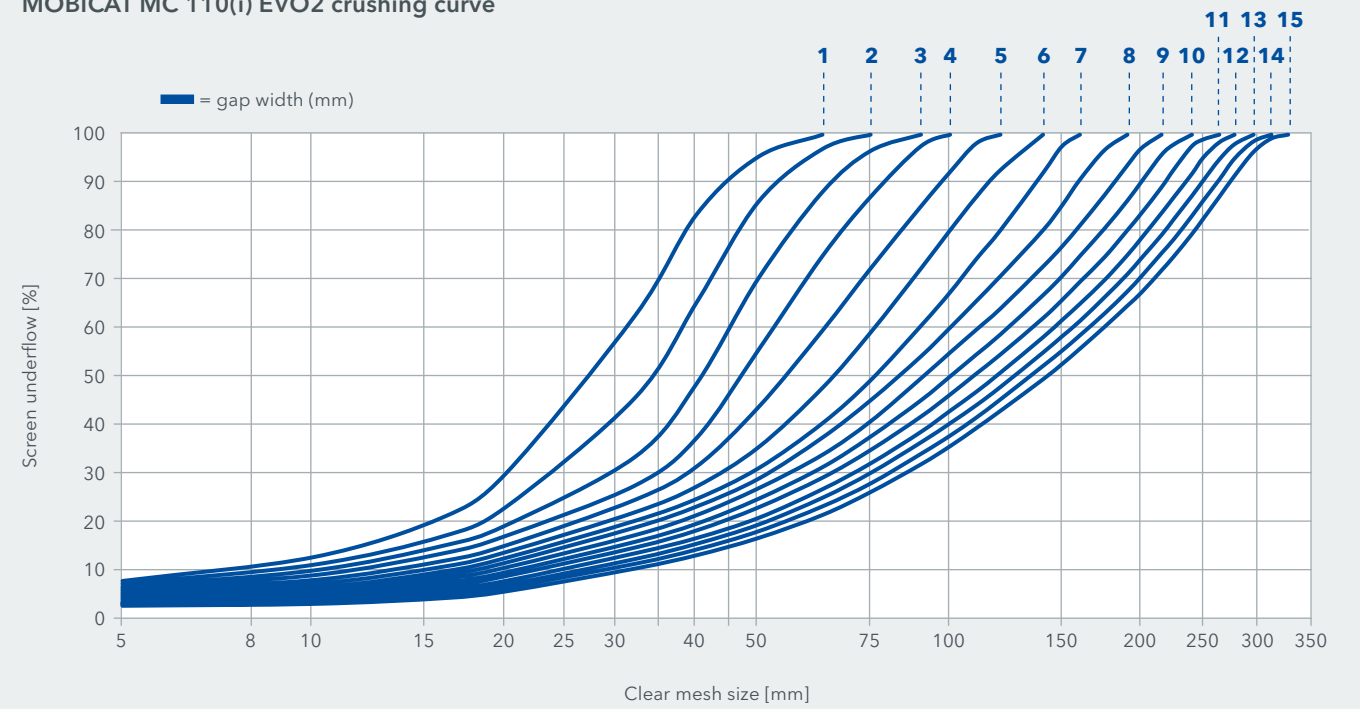

CSS (CLOSED SIDE SETTING)

- 01 40 mm 02 50 mm 03 60 mm 04 70 mm 05 80 mm 06 90 mm 07 100 mm 08 110 mm 09 120 mm 10 130 mm
- 11 140 mm 12 150 mm 13 160 mm 14 170 mm 15 180 mm

YOUR WIRTGEN GROUP CUSTOMER SUPPORT

Service you can always rely on.

Place your trust in our reliable and fast support during the complete life cycle of your machine. Our wide service offer includes suitable solutions to meet all of your challenges.



Service

We keep our service promises - with fast and uncomplicated assistance both on the building site as well as in our professional workshops. Our Service team has received expert training. Thanks to special tools, repair, care and maintenance work is completed quickly. Upon request, we can support you with tailored service agreements.

> www.wirtgen-group.com/service



Spare parts

Original parts and accessories from KLEEMANN can ensure the high reliability and availability of your machines in the long term. Our experts will be glad to advise you on application-optimised wear part solutions. Our parts are available worldwide, at any time and are easy to order.

> parts.wirtgen-group.com



Training

Staff responsible for the WIRTGEN GROUP's product brands are specialists in their areas and have decades of application experience. Our customers also greatly benefit from these experts. In our WIRTGEN GROUP training courses, we gladly pass on our knowledge to operators and service personnel.

> www.wirtgen-group.com/training



Telematics solutions

Construction machines with leading technology and perfected telematics solutions work hand-in-hand in the WIRTGEN GROUP. Intelligent monitoring systems such as WITOS or JD Link* not only facilitate the maintenance planning of your machines but also increase productivity and economy.

> www.wirtgen-group.com/telematics

PROFESSIONAL CRUSHING TOOLS

For less wear and optimum results.

KLEEMANN offers a very wide range of parts and accessories. The selection of the correct crusher jaws, in particular, has a strong influence on the result: for abrasive rock, for example, different crusher jaws have to be used than for coarse rock.

The crushing principle

The crushing material is crushed by the jaw crushers in the wedge-shaped pit between the fixed crusher jaw and the crusher jaw articulated on an eccentric shaft. The material is crushed by the elliptic course of movement and transported downwards by gravity. This occurs until the material is smaller than the set crushing gap.

In ideal operation, the main wear occurs in the lower half of the crusher jaw. If the teeth are completely worn (smooth crusher jaw), the crusher jaw should be turned over or replaced. The crushing capacity (t/h) is reduced considerably when the crusher jaws are smooth because the material is mainly crushed and no longer broken. The machine requires more power to break, which results in unnecessarily high operating costs, faster wear and poorer crushing results.

Low-wear material

The crusher jaws installed in jaw crushers from KLEEMANN are made from a special manganese casting characterised by excellent durability of the basic body. Through the compressive load, the manganese casting forms a highly wear-resistant surface during operation to ensure a long service life.

Timely replacement of worn crusher jaws improves the crushing results while considerably reducing operating costs.

KLEEMANN > PROCESS KNOWLEDGE

Optimised results through correct loadings:

- > The optimum fill height of the jaw crusher up to the bevelling of the crusher jaws should not be exceeded
- > Continuous overfilling leads to premature wear, reduced service life of bearings and damage to the prescreen
- > Continuous underfilling leads to uneven wear, a poor grain shape and reduced plant performance
- > The maximum feed size of 90% of the feed opening should be observed
- > The CSS should always be correctly set

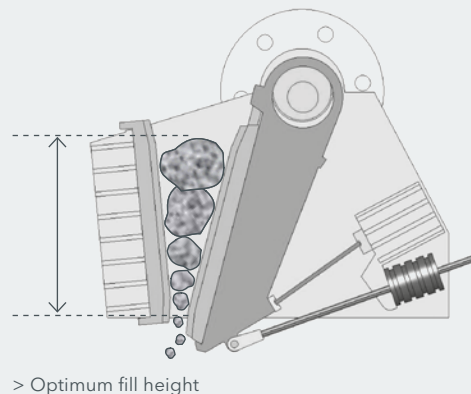

RATIO OF SERVICE LIFE AS A PERCENTAGE

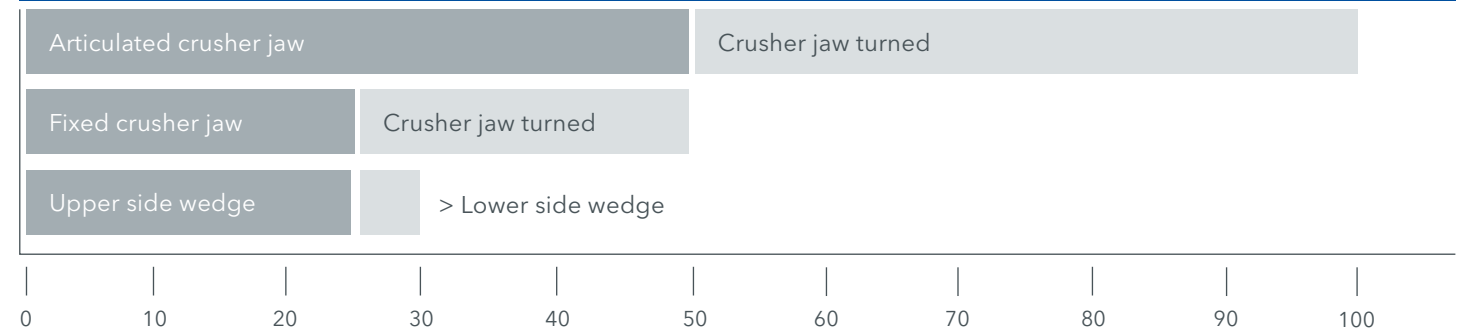

RECOMMENDED USE OF CRUSHER JAWS

Tooth shape	Feed material				
	Hard stone	Soft and medium-hard rock	Gravel	Rubble/ Recycling	Laminated medium-hard rock
RT* (regular teeth)	●	●●	●●	●●	●●
ST* (sharp teeth)	●	●	●●	●	●●
WT (wavy teeth)				●●	

●● Highly recommended ● Recommended ● Not recommended

CRUSHER JAW PROPERTIES

Tooth shape	Illustration	Properties
RT* / ** (regular teeth)		Well-balanced in terms of service life, energy requirements and crushing pressure; suitable for natural stone and recycling.
ST* (sharp teeth)		Sharp teeth reduce the laminated share in the crushed material. Recommended with small gap widths (< 60 mm); suitable for gravel.
WT (wavy teeth)		Thanks to their special tooth profile, adhering of the cohesive material is clearly reduced or avoided; use in recycling

* Two quality levels available: > XPERT with 18 % manganese > XTRA with 20 % manganese
 ** also with chrome inlays, with abrasive natural stone for a longer service life

CRUSHER JAWS

The originals.

Depending on the application and material properties, various crusher jaws are available to achieve optimum results.



CRUSHER JAW RT-XPERT / CRUSHER JAW RT-XTRA



- > Ideally balanced properties in relation to service life, energy requirements and crushing pressure
- > Ideal tooth spacing for best possible removal of the fines
- > Reduces flaky shares in the crushed material
- > XTRA with higher manganese content for extreme applications



Application options

- > **Natural stone:** slightly to medium abrasive material
- > **Recycling:** rounded material (abrasive), rubble

CRUSHER JAW ST-EXPERT



- > Good grip on material thanks to sharp tooth profile
- > Reduction of flaky share in crushed material due to sharp tooth profile
- > Recommended with small gap widths (< 60 mm)



Application options

- > **Recycling:** rounded material (less abrasive)



CRUSHER JAW WT



- > Reduced adhesion of cohesive material thanks to special tooth profile
- > Optimised geometry of the rear wall of the crusher jaws, for improved draw-in angle inside the crushing chamber
- > Recommended for seriously contaminated material

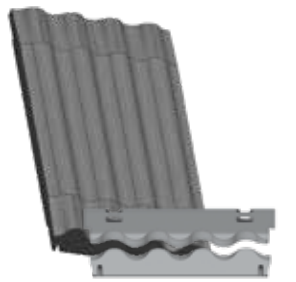

Application options

- > **Recycling:** rubble

Further information: parts.wirtgen-group.com

TECHNICAL DATA AT A GLANCE

MOBICAT MC 110(i) EVO2



TECHNICAL DATA

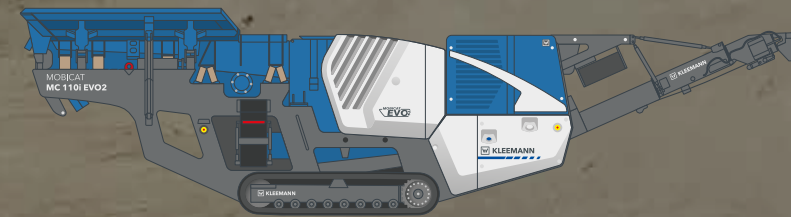

MC 110(i) EVO2

- > Crusher inlet (W X D): 1,100 x 700 mm
- > Feed capacity: 400 t/h
- > Weight: 42,500 - 49,000 kg

**KLEEMANN GmbH**

Manfred-Wörner-Str. 160
73037 Göppingen
Germany

T: +49 7161 206-0
M: info@kleemann.info

 www.kleemann.info